

**Manual for
MantraJet 1050
CD/DVD auto-printer**



YUREX



**Rev 1.02
September 7, 2010**

Table of contents

Specifications.....	3
Unpacking MantraJet 1050.....	4
Quick installation reference MantraJet 1050.....	7
Installation of MantraJet 1050 printer.....	8
Driver installation.....	8
Installing ink cartridges:.....	12
Buttons and LED Lights indicators:.....	13
Cancel button.....	13
Cartridge LED.....	13
Resume button / LED.....	13
Power On /Off.....	13
Printer Driver Settings 2.xxx series:.....	14
Features tab:.....	14
Color tab:.....	15
Mask Settings tab:.....	16
Printer Services:.....	17
Estimated Ink Levels.....	17
Device Services.....	17
Clean the Printheads.....	17
Printer Alignment Services:.....	18
Test print button.....	18
Printer Driver Settings 1.xxx series:.....	19
Paper quality tab:.....	19
Basic tab:.....	20
Color tab:.....	21
Mask Settings tab:.....	22
Utilities tab:.....	23
Test print.....	23
Clean ink nozzles.....	23
Diagnostics print.....	23
Ink level.....	23
Alignment tab:.....	24
Maintenance:.....	25
Cleaning the printer's cover.....	25
Cleaning the printer's interior components.....	25
Cleaning the ink cartridges.....	26
Using control panel:.....	26
Using print dialog box:.....	26
Upgrading MantraJet 1050 Driver:.....	27
Remove current MantraJet 1050 driver.....	27
Install new MantraJet 1050 driver.....	28
FAQ:.....	29

Specifications

Supported media:	Inkjet printable 120mm		
Disc capacity:	50		
Maximum Resolution:	4800 DPI		
Supported cartridges:	Black:	HP56 (C6656A), or HP27 (C8727AN)	
	Tri-color:	HP57 (C6657A), or HP28 (C8728AN)	
Physical specifications:	Width:	17.7 inches	(450mm)
	Height:	9.5 inches	(240mm)
	Length:	20.7 inches	(525mm)
Electrical specifications:	Input voltage:	100-240V AC	
	Input frequency:	50-60 Hz	
PC minimum specifications:	Processor:	Pentium 233Mhz	
	Memory:	256 MB	
	Free disc space:	50MB	
Supported Operating Systems:	Windows 7, Windows Vista, Windows XP (Service Pack 2), Windows 2000		

Unpacking MantraJet 1050

Package contains the following parts:

MantraJet 1050 CD/DVD auto-printer

CD Input tray holders (set of 4)

CD Output tray

Power cord

USB cable

Black ink cartridge

Color ink cartridge

Installation CD with:

MantraJet 1050 operating manual

Discus 4.0 label editing software made by Magic Mouse.

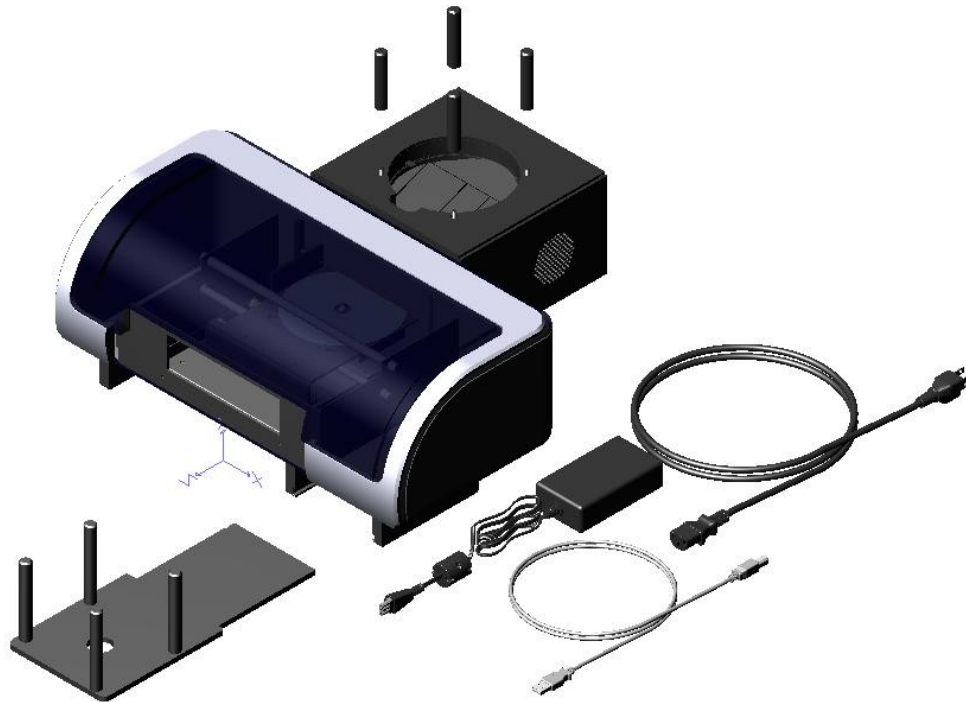

Fig. 1 Box's contents.

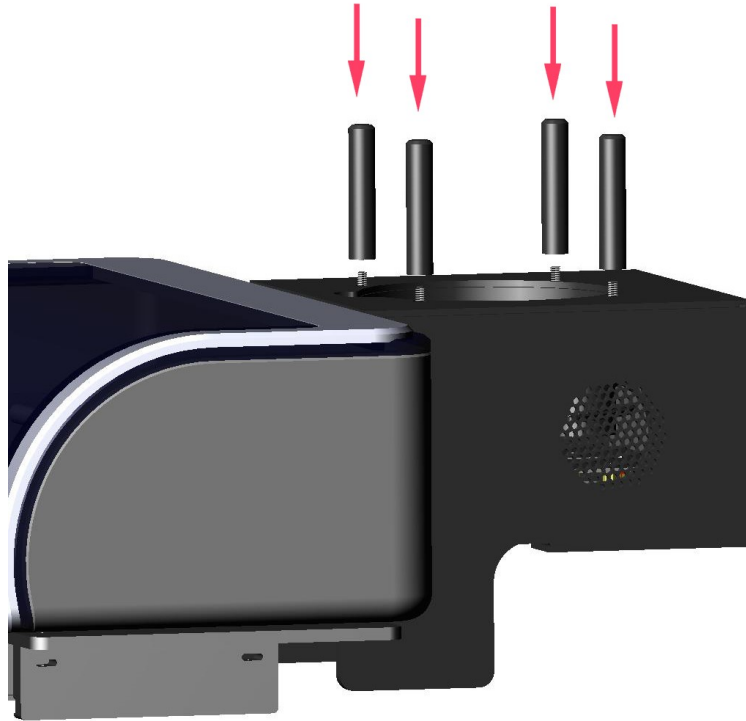

Fig. 2 Mounting the input holders

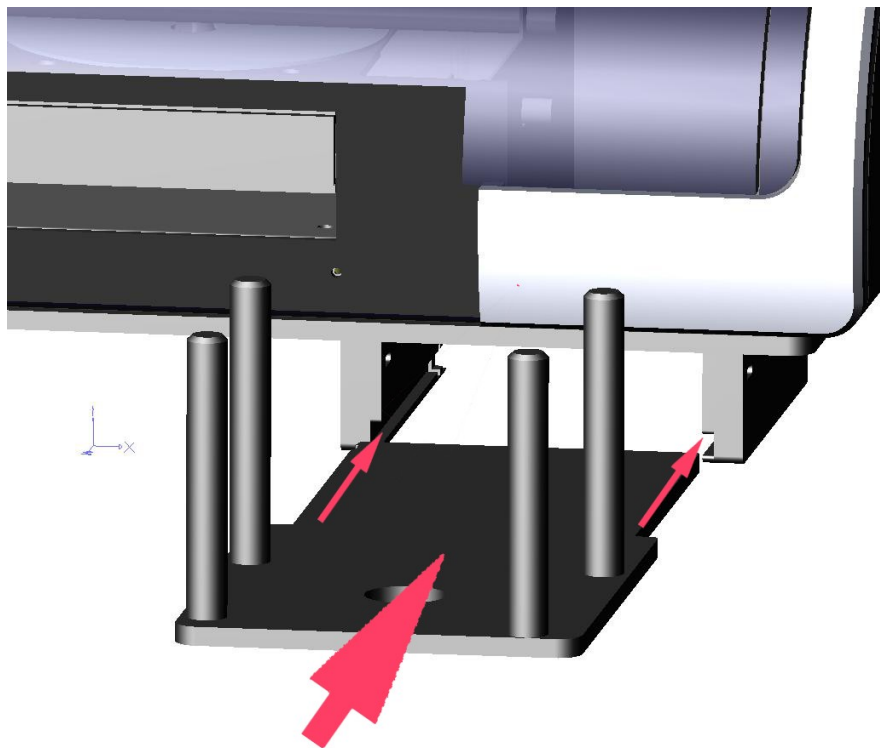

Fig. 3 Mounting the CD/DVD output tray

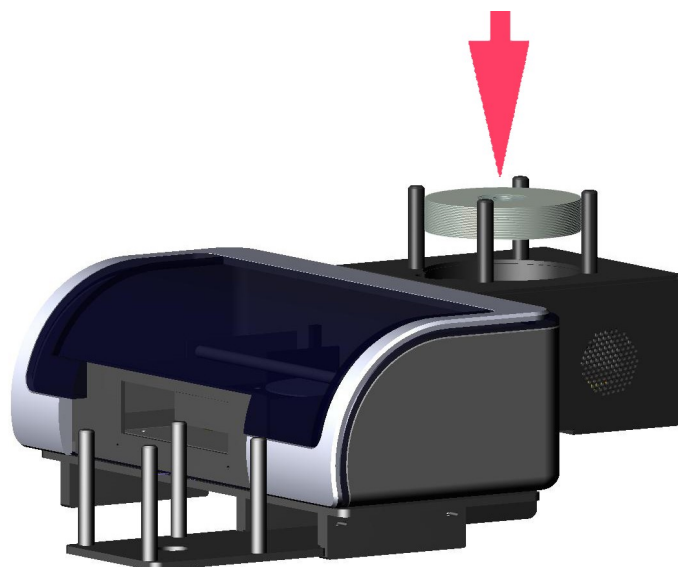

Fig. 4 Inserting the discs in the CD input holder

Quick installation reference MantraJet 1050

1. Run the driver installation software on the driver CD.
2. Install the Discus Label software.
3. Place the printer on the flat leveled surface.
4. Removed plastic tight wrap from printer's tray.
5. Screw 4 CD input holders (short black rods) to the back part of the printer.
6. Insert the CD output tray into the rails on the front bottom part of the printer.
7. Insert the female part of the AC power cable to into the power supply brick.
8. Insert the small plug of the power supply to the back of the printer.
9. Connect AC cord to the outlet (Green LED on the right side of a printer should turn on).
10. Lift printer cover.
11. Unwrap and insert a black ink cartridge (HP 27) on the right side of a carriage.
12. Unwrap and insert a color ink cartridge (HP 28) on the left side of a carriage.
13. Close printer cover.
14. Wait until printer initializes ink cartridges, look for green orange LEDs on the left side of the printer to stop blinking. This might takes about 2 minutes.
15. Connect the printer to your computer using the USB cable. The USB connector is located on the right side on the back of a printer.
16. Your computer should detect a new printer is connected.
17. Install the MantraJet 1050 driver using the “Install driver automatically” option.
18. Place up to 50 inkjet printable discs in the input hopper.
19. Start a Discus Label software or a preferred graphics software.
20. Congratulations – you have successfully completed printer installation. Just select “Print”, select MantraJet 1050, enter a number of copies and enjoy.

Installation of MantraJet 1050 printer

Driver installation

CAUTION: Start the installation with the printer disconnected from your computer.

1. Insert the MantraJet 1050 software CD into the disk drive on your computer. You should see the following dialog.

If the software does not run automatically, you can run it manually using the following steps:

- I. Click the **Start** button on the bottom left of the Window's task bar.
- II. Click **Run**.
- III. A dialogue box will open. On the bottom right, click on **Browse**.
- IV. Click on **My Computer**.
- V. Double-click on **DVD/CD-ROM Drive** and select the Mantra1050 Driver disk that you see listed.
- VI. Double click on **Setup.exe** file.

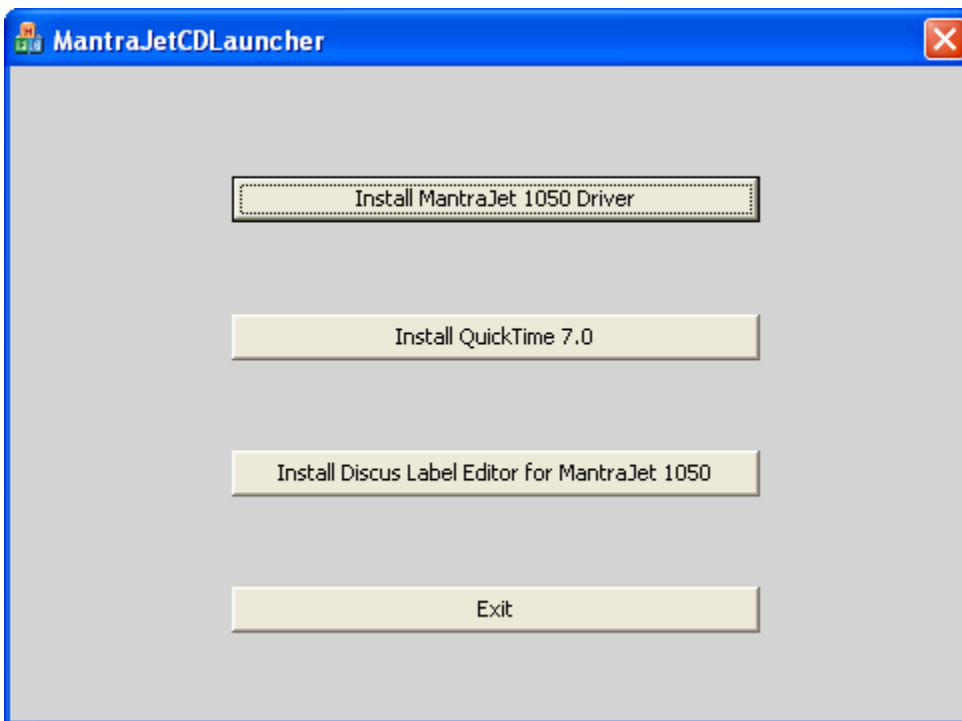

Click "Install MantraJet 1050 driver" button.

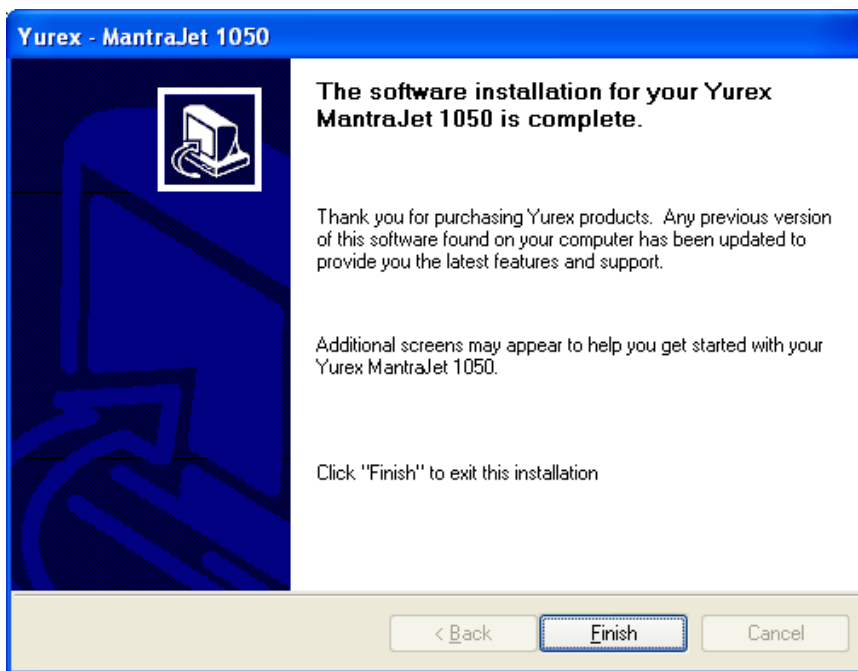
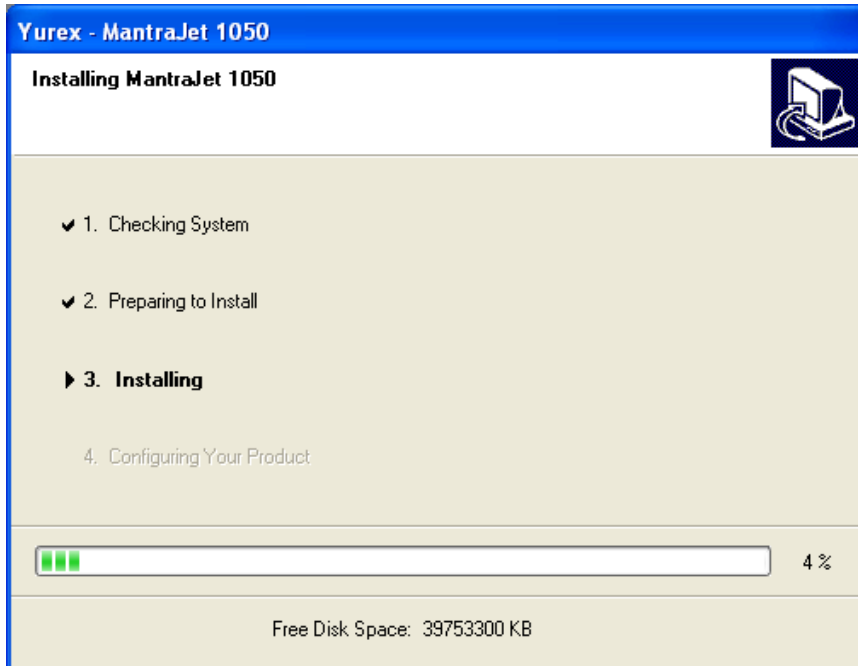

- Click "Finish" button to complete the driver files installation.
2. Connect a MantraJet 1050 printer to the USB port of the computer.
A Hardware Wizard dialogue box will appear.



Click “No, not at this time”.

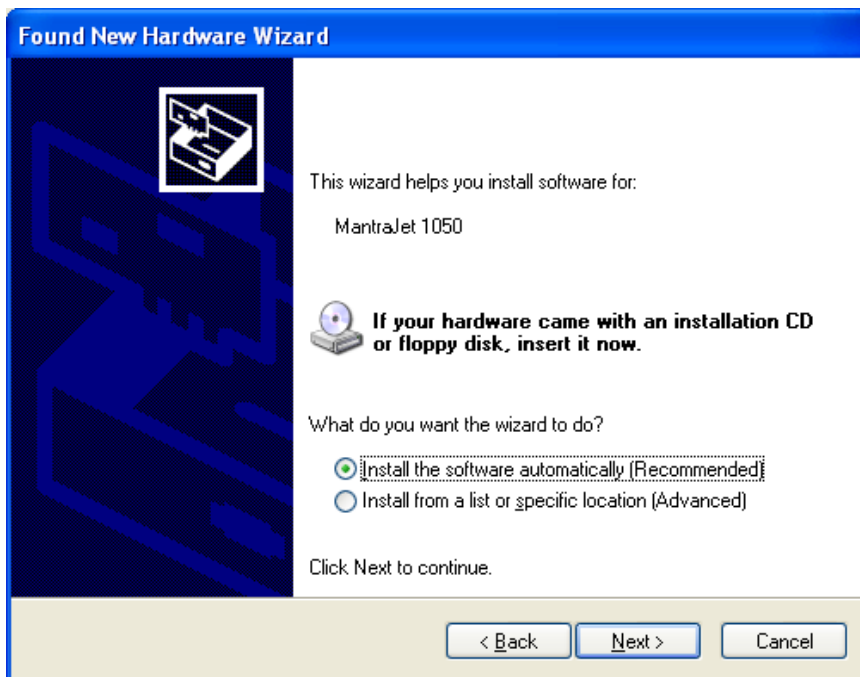

3. Click “Install software automatically (Recommended)” on this dialog.

Mantra 1050 driver files will be found automatically.

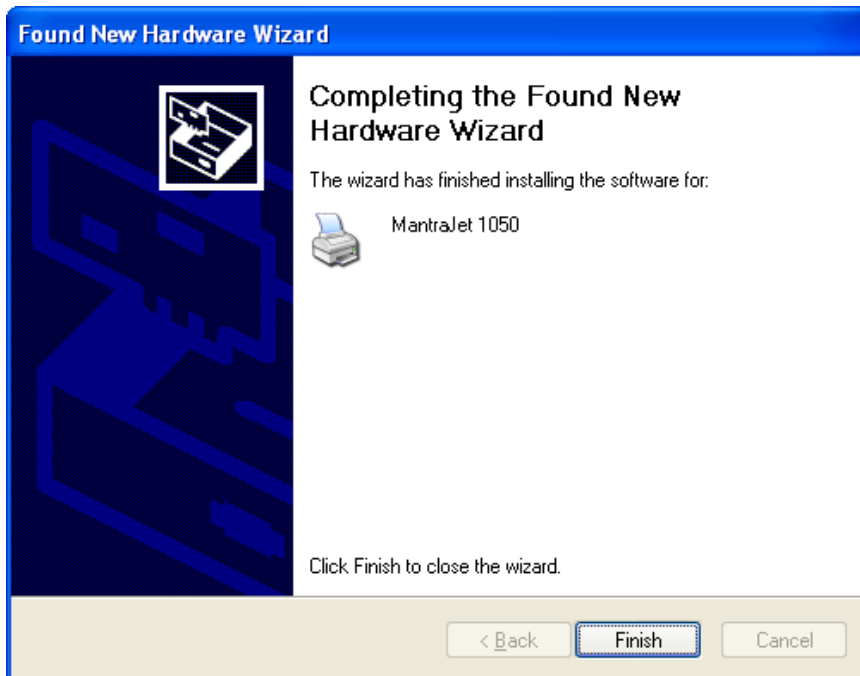

Click on “Finish” button to complete the driver installation.
The installation process is now complete!

4. Confirm printer driver installation.

Click the **Start** button on the bottom left of the task bar, then click **Printers and Faxes**.

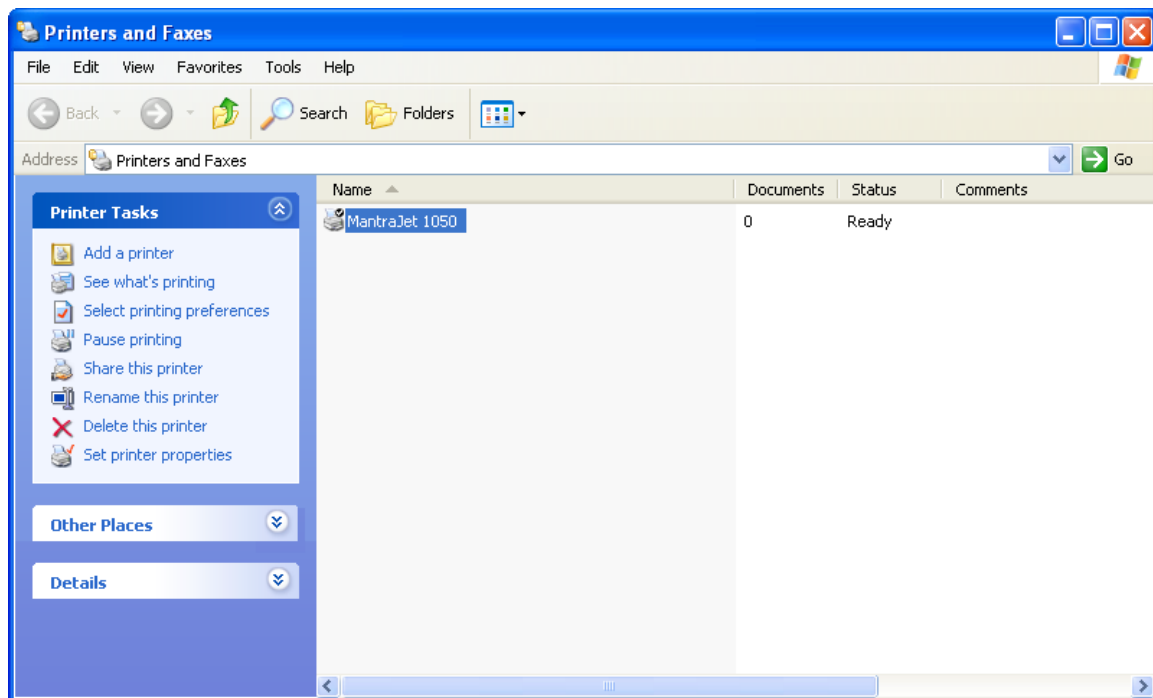

Installing ink cartridges:

1. Turn the printer on.
The ink cartridge cradle will not move if the power is not on.
2. Open the large printer cover.
3. Wait until the ink cartridge cradle moves to the right side of the printer and is idle and quiet.
4. Remove the new ink cartridge from its packaging and carefully remove the protective plastic tape. Hold the print cartridge so that the copper strips are on the bottom and are closest to the printer.



CAUTION: Do not touch the print cartridge ink nozzles or copper contacts. Touching these parts will result in clogs, ink failure, and bad electrical connections. Do not remove the copper strips. They are required electrical contacts.

5. Snap open the blue (color ink) and gray (black ink) cartridge covers.

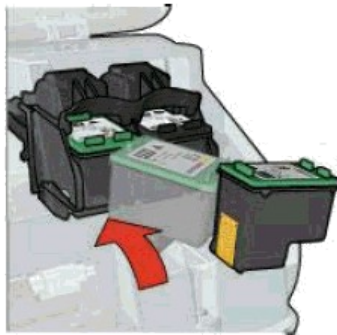

6. Slide each print cartridge into its designated cradle at a slight upward angle until the cartridge snaps into place. Please do not force the ink cartridge. Snap the cartridge covers closed.
7. Close the printer cover and wait. The printer will take about a minute to initialize the cartridges. If you are replacing a print cartridge, press down on the print cartridge to be replaced, and then slide it out of the print cartridge cradle.

Buttons and LED Lights indicators:



Cancel button

Cancels the current print.

Cartridge LED

Flashing LED might indicate ink cartridges ink levels are low.

Flashing LED might indicate improper cartridge installation.

Flashing LED might indicate a printer cover is open.

Solid LED might indicate when ink cartridges failed to initialize.

Solid LED might indicate when ink cartridges are not installed.

Resume button / LED

The LED serves to indicate attention is needed.

Flashing LED might indicate an error.

Flashing LED might indicate empty input bin.

Press a flashing button clears an error.

Press a flashing button resumes printing.

Press a button to open or close a disc tray.

Press a button to load a disc on a disc tray.

Power On /Off

This button turns the printer on and off. The power LED flashes when the printer is processing.

Note: Any other buttons or LED lights are not used or defined.

Printer Driver Settings 2.xxx series:

Features tab:

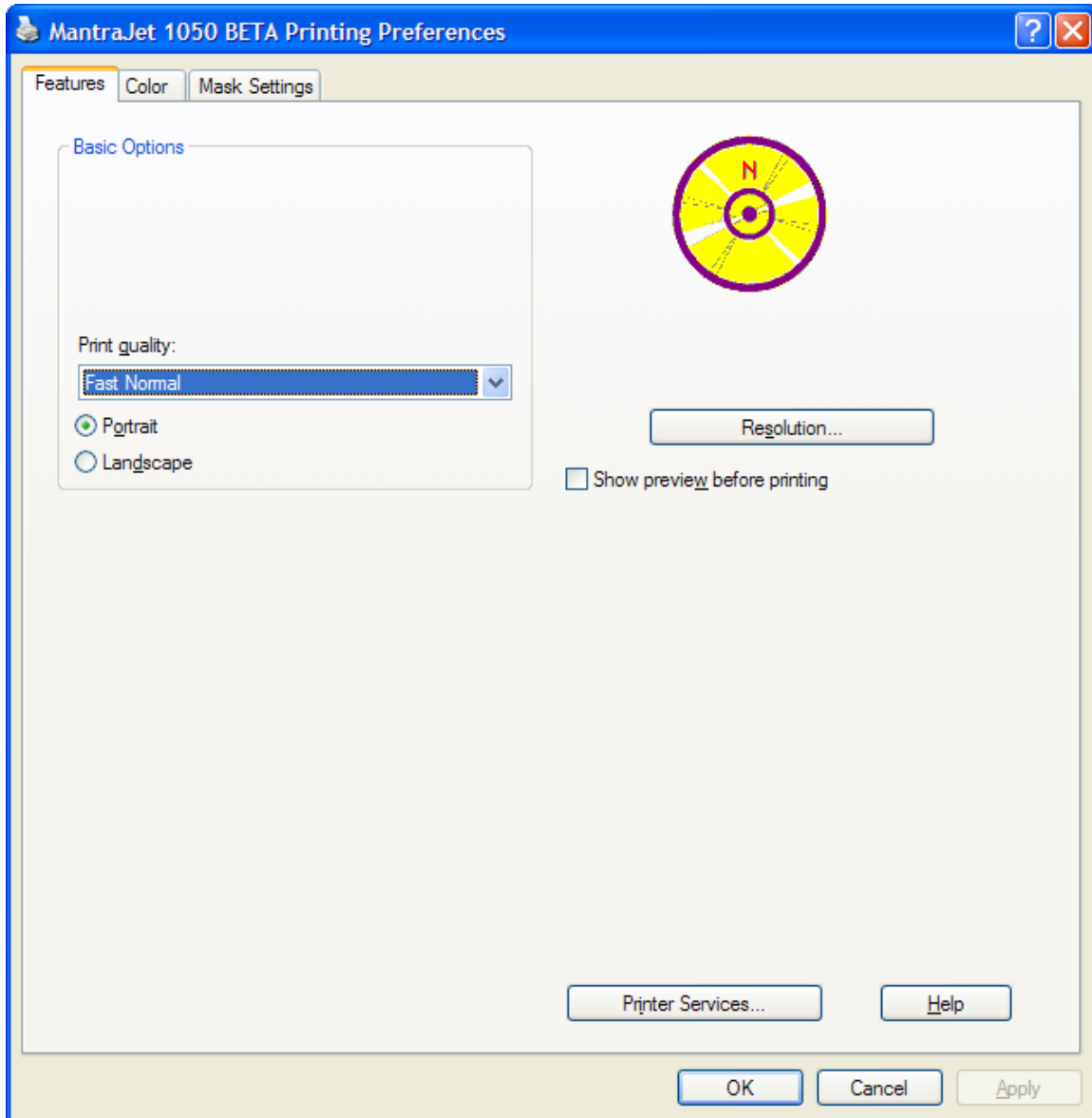

When changing the print quality setting, it is important to understand trade-off between print quality and print speed. The higher print quality the more time it will take to print a disc.

One can change print orientation to Portrait or Landscape without using graphics software.

Color tab:

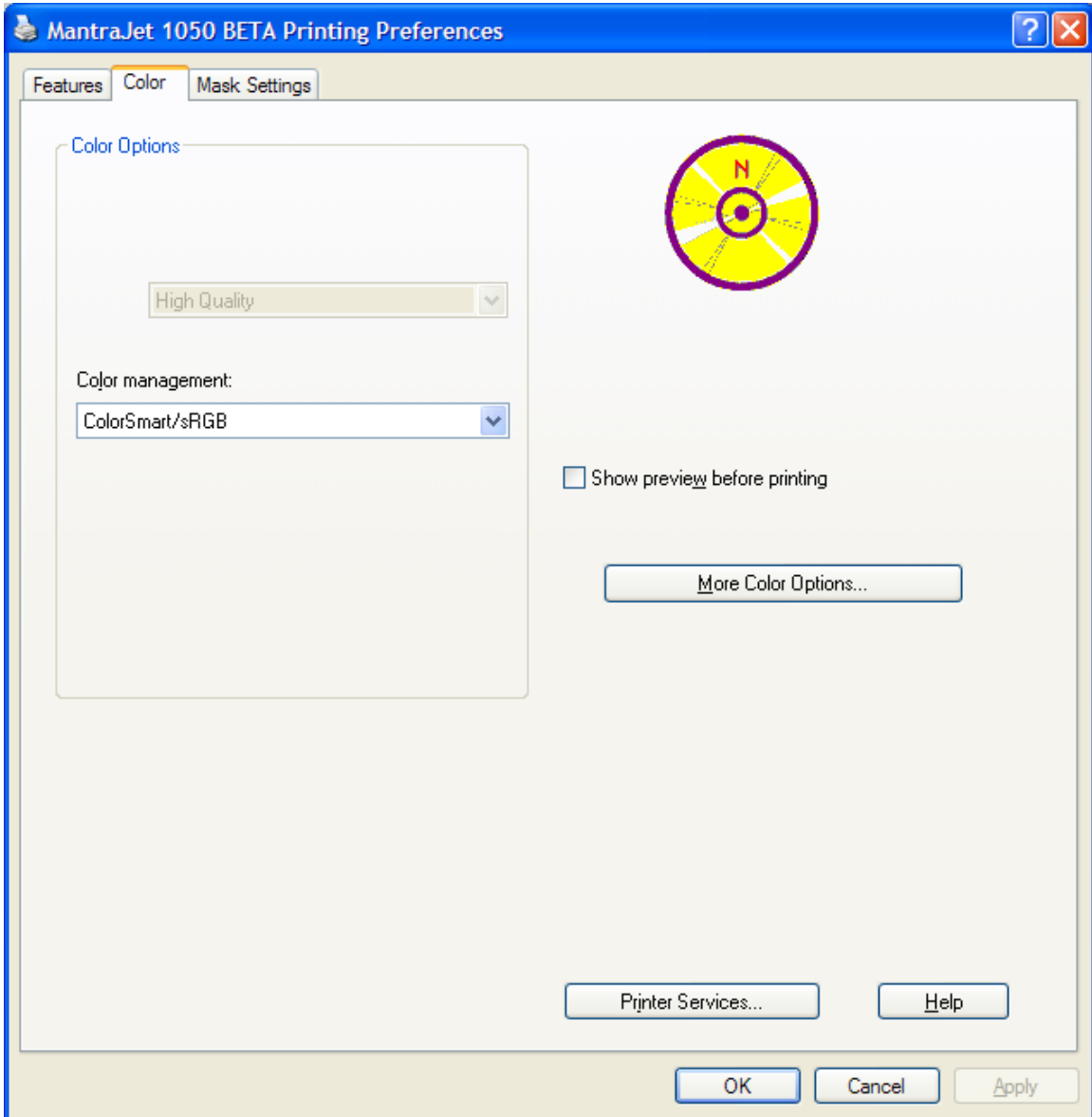

Mask Settings tab:

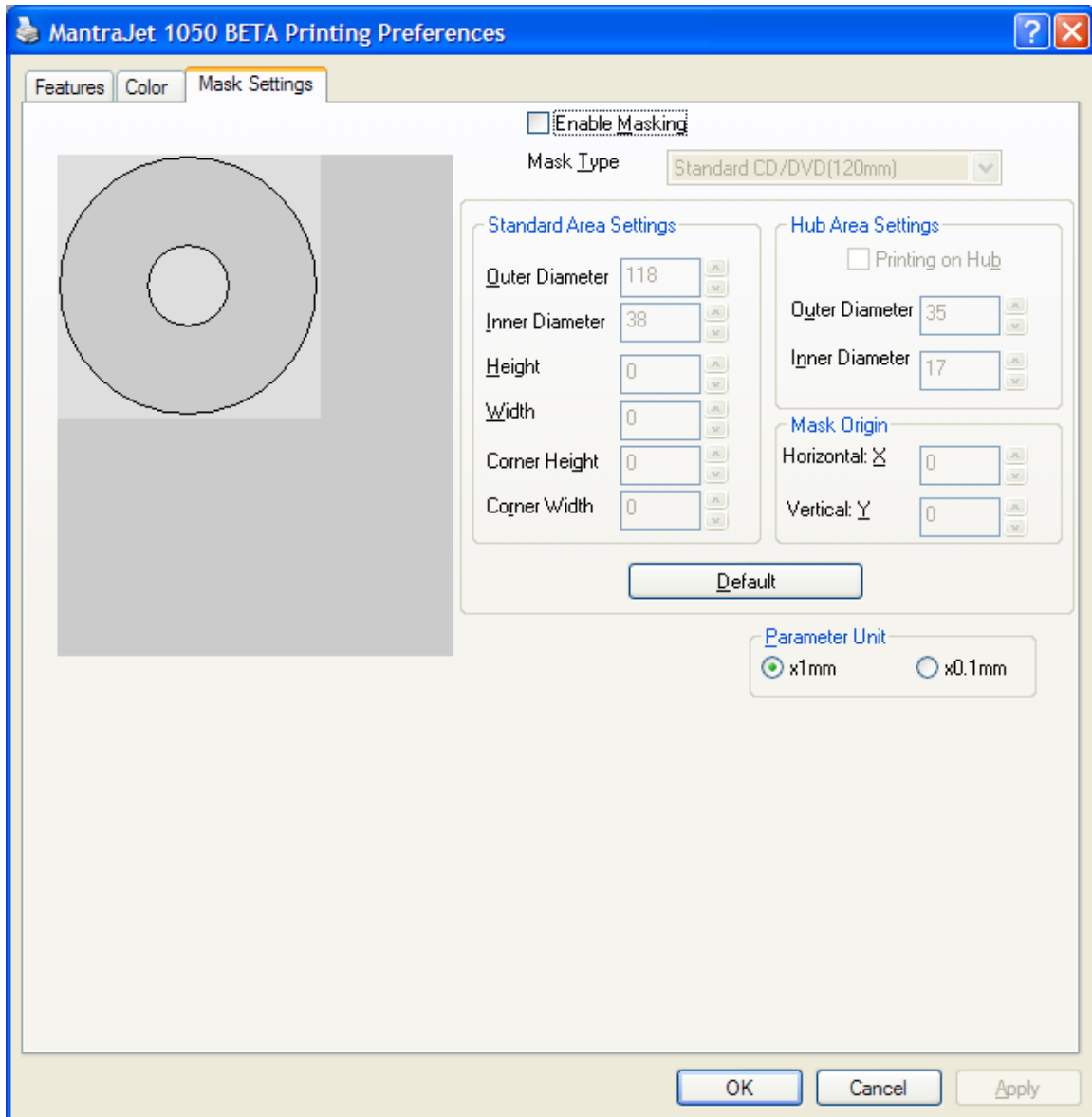

NOTE: It's recommended to disable mask settings.

Printer Services:

Printer services option can be access from either a Features or a Color tab of a Printing Preferences.

Estimated Ink Levels

Displaying the ink level.

NOTE: Ink level feature works only when a MantraJet 1050 is printing.

Device Services

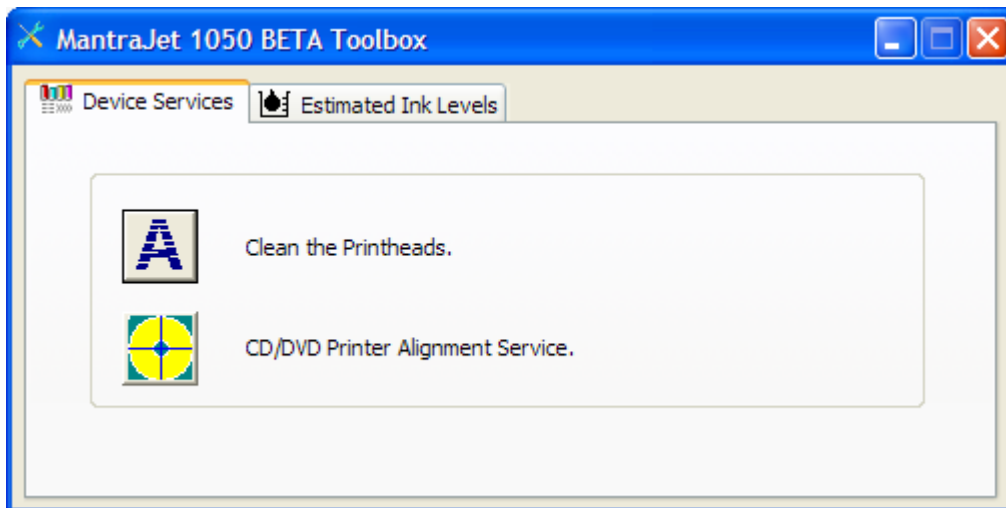

Clean the Printheads

Cleans ink cartridges' nozzles. Use a test print button to check if ink cartridges need cleaning.

Printer Alignment Services:

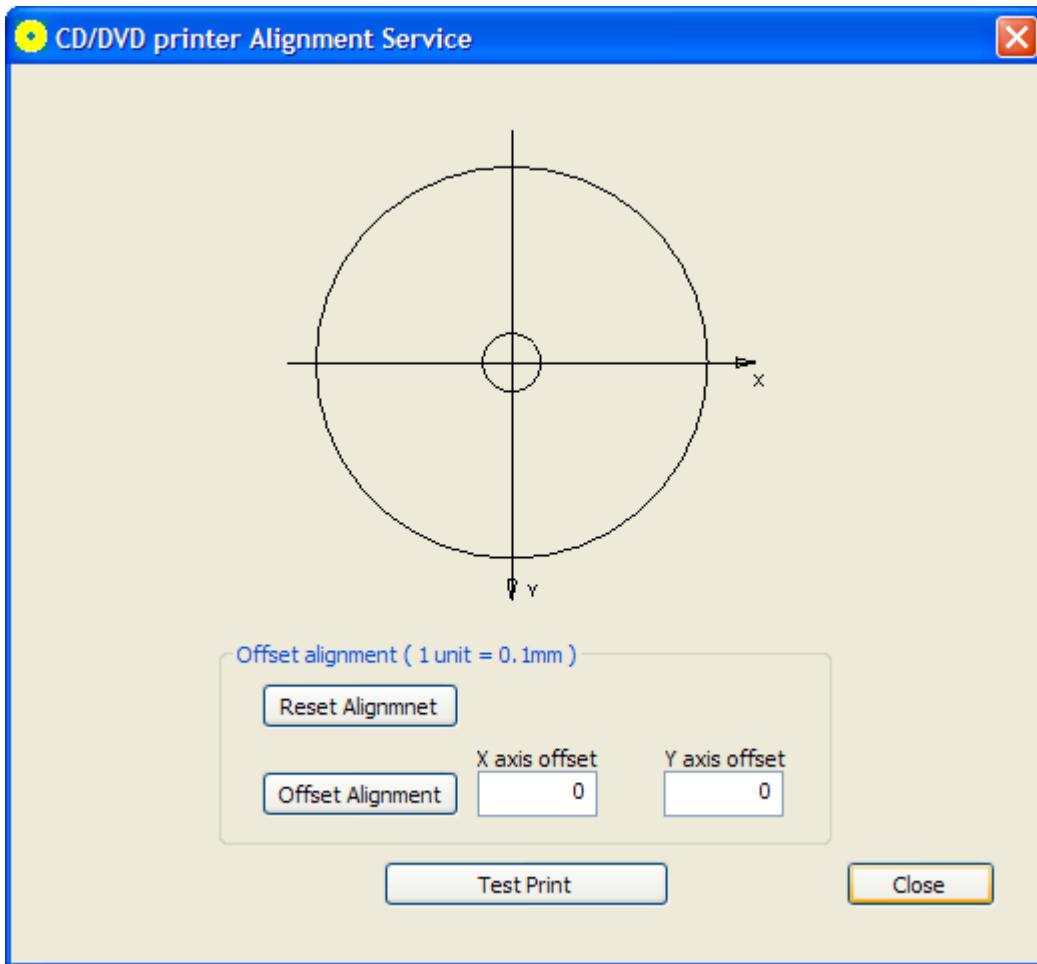

MantraJet 1050 is a mechanical device, thus a minor misalignment may occur due to the handling of the printer. MantraJet 1050 allows correcting the undesired offset of the printable area. Use the “Test print” button in the “Utilities” tab to print a diagnostics image. If the circle is offset you can simply enter the desired offset and click the “Offset” button. Offset values are **RELATIVE TO THE CURRENT ALIGNMENT**.

To shift an image to the left side, use negative value for X axis offset, when offset to the right side is needed use positive value.

To shift an image to the top, use negative offset for Y axis offset, when offset to the bottom is needed use positive value.

Use the **Reset Alignment** button to return to factory default offset of the printer.

NOTE:One must clicking on the Offset button for the change to take effect. Both X and Y values will reset to zero and the tool is ready to use for another offset.

Test print button

Prints an alignment and diagnostics pattern on a disc.

Printer Driver Settings 1.xxx series:

Paper quality tab:

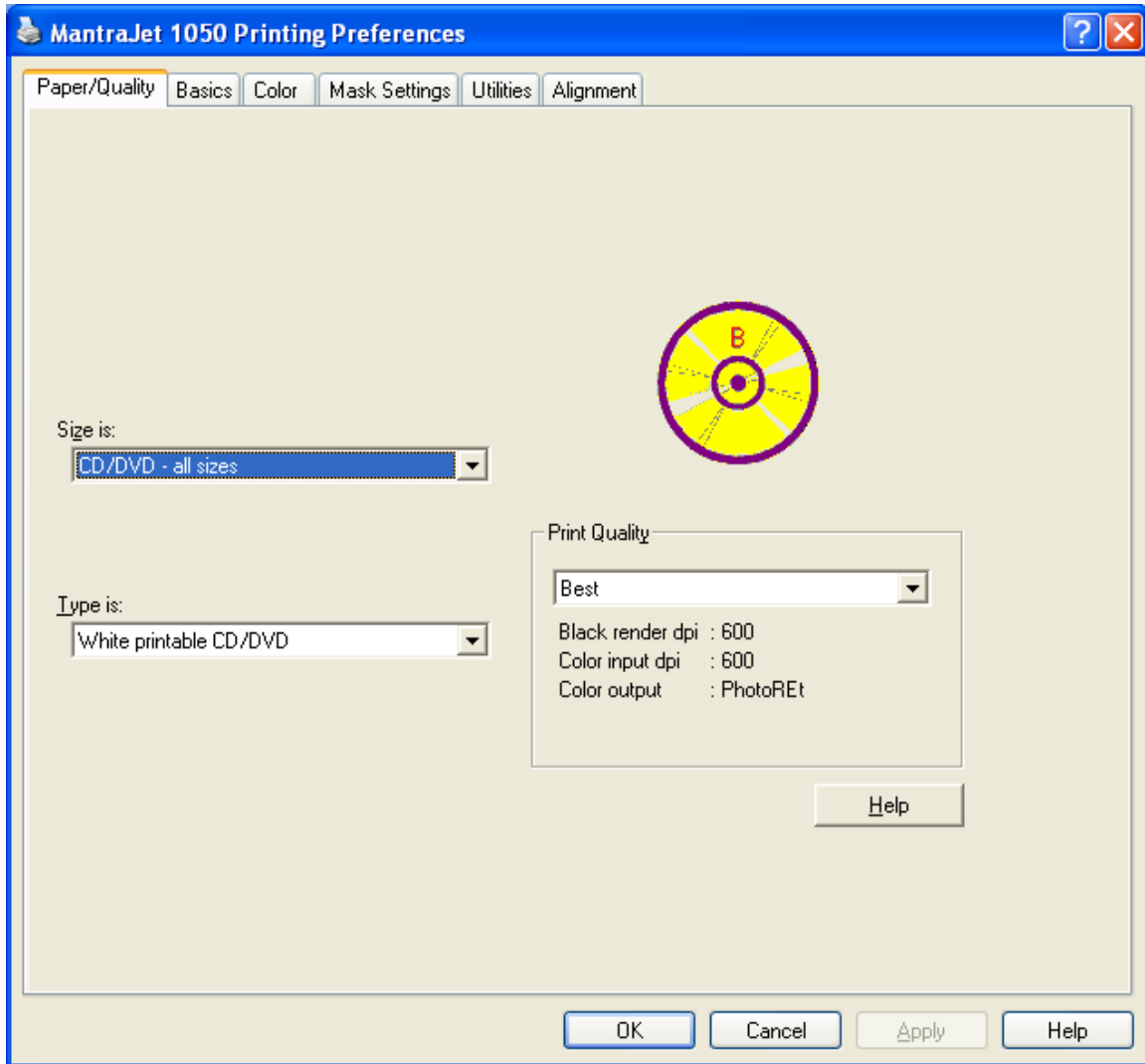

When changing the print quality setting, it is important to understand trade-off between print quality and print speed. The higher print quality the more time it will take to print a disc.

Basic tab:

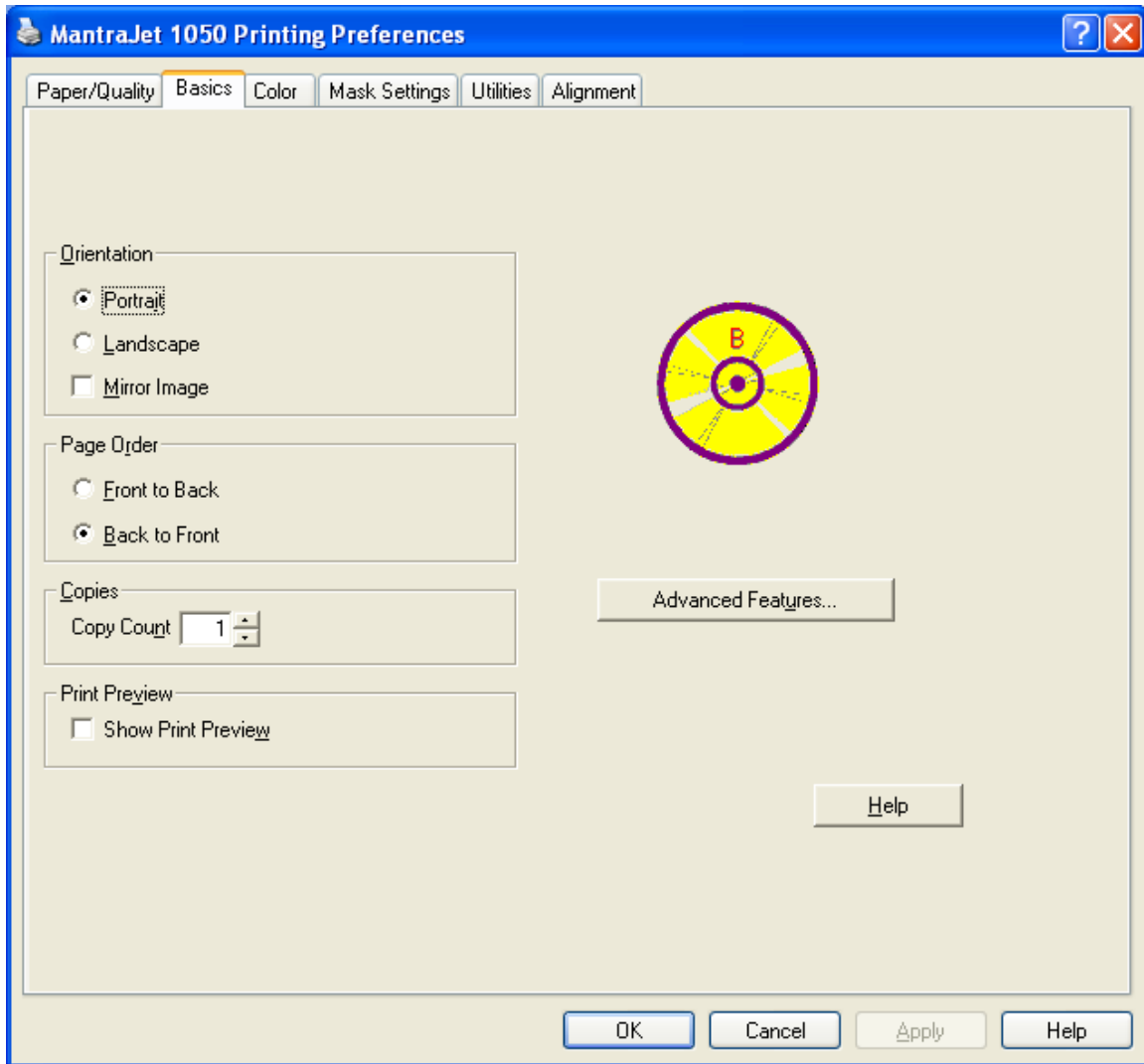

One can change the orientation to Portrait, Landscape or mirror an image within the driver without using graphics software.
To adjust the ink volume use “Advanced features” button.

Color tab:

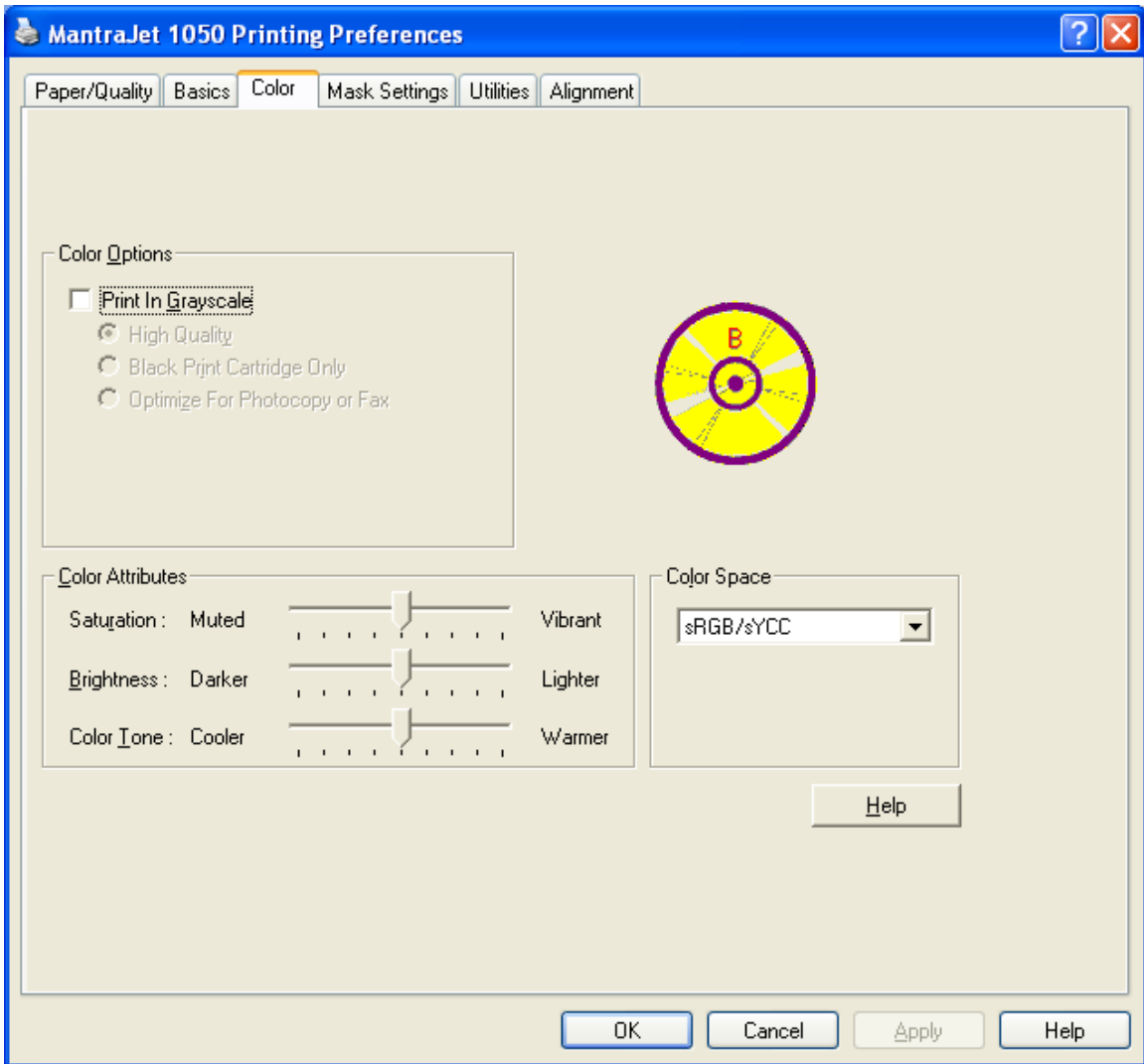

NOTE: Do not use the “Black Print Cartridge Only” option because of a known problem with HP driver module which has not been resolved in the present release of MantraJet 1050 driver.

Mask Settings tab:

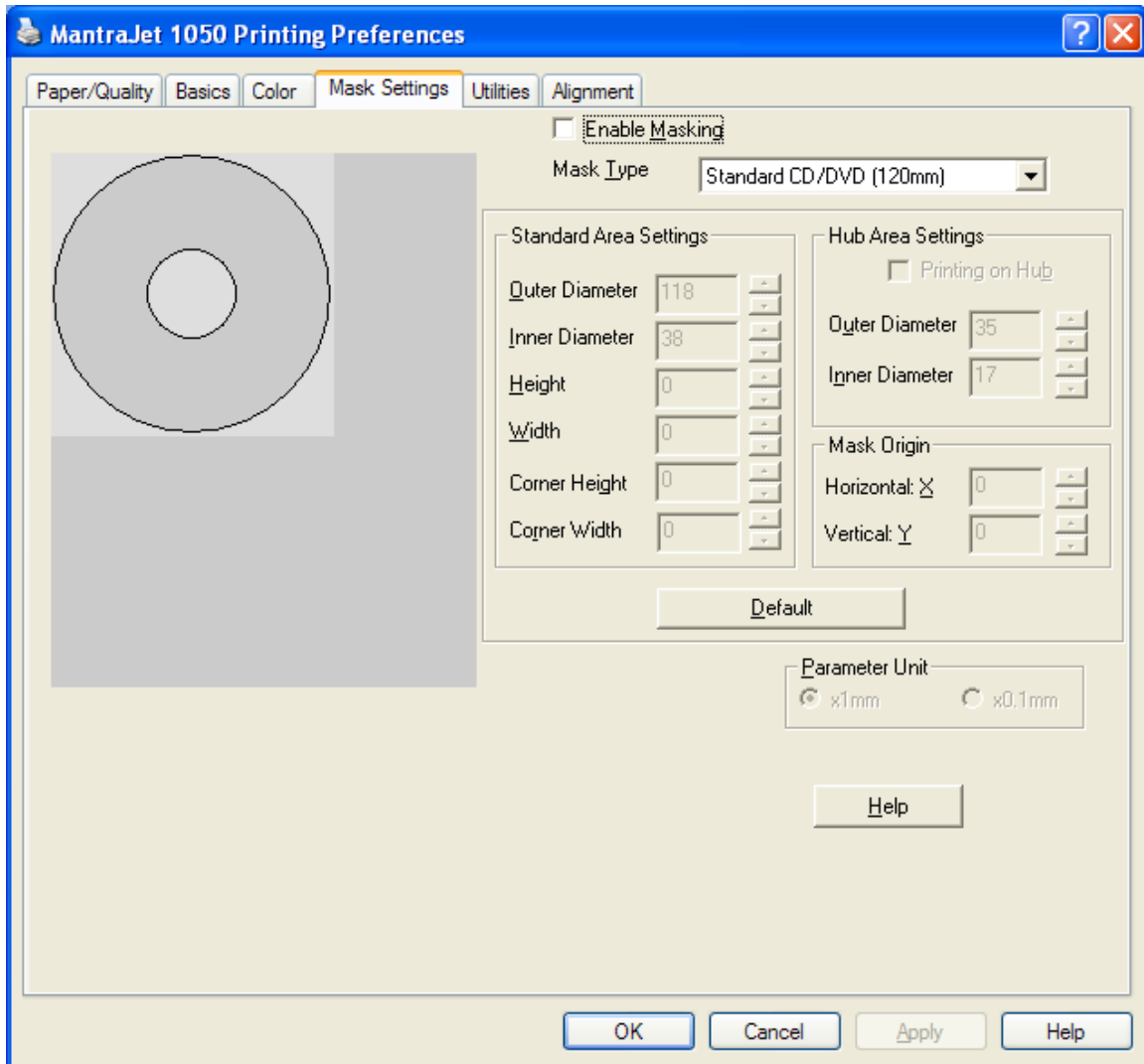

NOTE: It's recommended to disable mask settings.

Utilities tab:

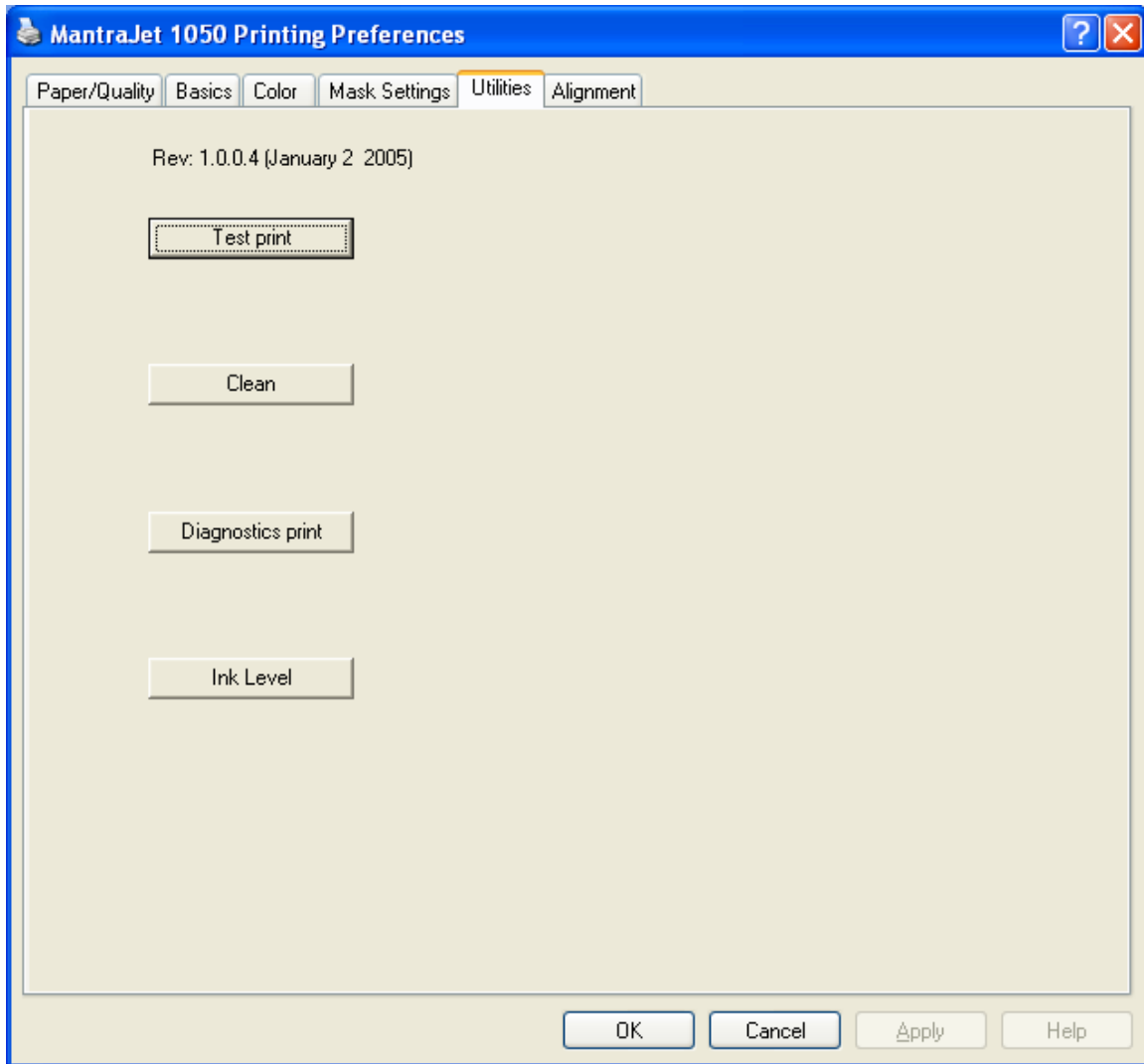

Test print

Prints an alignment and diagnostics pattern on a disc.

Clean ink nozzles

Cleans ink cartridges' nozzles. Use a test print button to check if ink cartridges need cleaning.

Diagnostics print

N/A

Ink level

Displaying the ink level.

NOTE: Ink level feature works only when a MantraJet 1050 is printing.

Alignment tab:

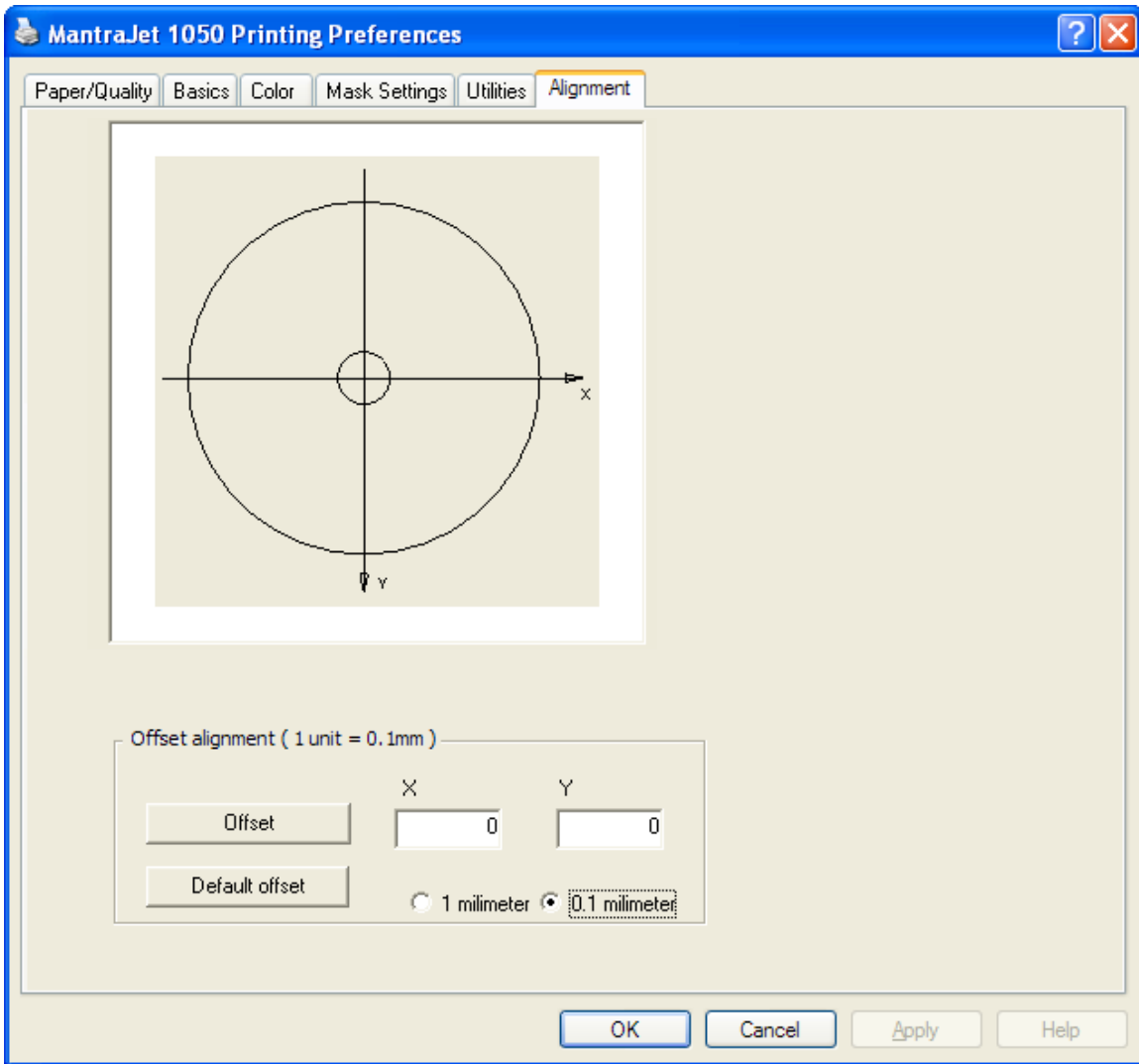

MantraJet 1050 is a mechanical device, thus a minor misalignment may occur due to the handling of the printer. MantraJet 1050 allows correcting the undesired offset of the printable area. Use the “Test print” button in the “Utilities” tab to print a diagnostics image. If the circle is offset you can simply enter the desired offset and click the “Offset” button. Offset values are **RELATIVE TO THE CURRENT ALIGNMENT**.

To shift an image to the left side, use negative value for X axis offset, when offset to the right side is needed use positive value.

To shift an image to the top, use negative offset for Y axis offset, when offset to the bottom is needed use positive value.

Use the “Default offset” button to return to factory default offset of the printer.

NOTE:One must clicking on the Offset button for the change to take effect. Both X and Y values will reset to zero and the tool is ready to use for another offset.

Maintenance:

Cleaning the printer's cover

Inkjet printers print by spraying a fine mist of ink from the print head onto the paper. In some situations, small amounts of ink from the printing process may be deposited on the printer case and become visible over time. If this situation occurs, the exterior of the printer can be cleaned with a soft cloth, moistened with water to remove ink deposits, dust, smudges, and fingerprints. A mild detergent may be used if necessary on the exterior. Do not use harsh household cleaners as they may damage the finish of the printer case.

Cleaning the printer's interior components

All inkjet printers produce a small amount of ink residue that may build up inside the printer's case. This is normal. There is no need to clean this residue. Alcohol or other cleaners may damage the printer and should not be used. Cleaning the interior of the printer should be limited to cleaning only the ink cartridges. Do not clean anything else inside the printer. Keep all liquids away from the inside of the printer.

CAUTION: Do not clean or lubricate the carriage rod. Cleaning or lubricating the rod may reduce its life. The ink present on the rod will not hinder the operation of the product. The carriage rod is the shaft inside the printer on which the print cartridges move back and forth.

Cleaning the ink cartridges

Clean the Inkjet print cartridges when lines or dots are missing from printed text and graphics. The missing lines and dots will appear as white lines throughout the text and graphics. This may be caused by the spray nozzles being clogged or by the cartridge running out of ink. If the inkjet print cartridge is running out of ink, replace the cartridge. If it is not low on ink, try one of the following solutions:

Using control panel:

- Click the Windows Start button in the bottom left corner of a task bar.
- Click the Settings.
- Click Control Panel.
- Double-click Printers And Faxes icon.
- Right-click on the MantraJet 1050 icon.
- Select Printing Preferences.
- Click the Utilities tab.
- Click the Clean button, then follow the on-screen instructions.

Using print dialog box:

- In the software application you are trying to print from, click File, then Print. The Print dialog opens.
- Click the Properties button and select the Services tab.
- Click the Utilities tab.
- Click the Clean button, then follow the on-screen instructions.

Upgrading MantraJet 1050 Driver:

It is highly recommended to remove the old drivers first prior to upgrading or reinstalling drivers.

1. Remove current printer driver.
2. Install new driver.

Remove current MantraJet 1050 driver

1. Click the **Start** button on the bottom left of the Window's task bar.
2. Click **Printers and Faxes**.
3. Select printer driver to delete.
4. Click **File** → **Delete**.
5. Click **Yes** to confirm.
6. Click **File** → **Server Properties**.
7. Click **Drivers** tab.

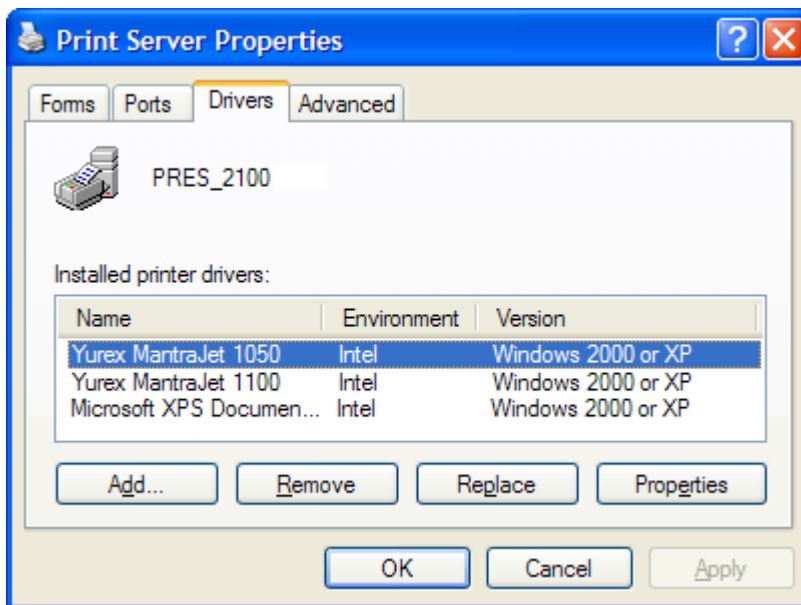

8. Select **MantraJet 1050**.
9. Click the **Remove** button.
10. Click **Yes** to confirm.
11. Close the **Printers and Faxes** window.
12. Restart computer.
13. MantraJet 1050 is now removed.

Install new MantraJet 1050 driver

1. Download and unzip printer driver
http://mantramediastore.com/drivers_mantrajet_page.php
2. Click the **Start** button on the bottom left of the Window's task bar.
3. Click **Printers and Faxes**.
4. Click **File, Add Printer**.
5. Click **Next**, confirming the Add Printer Wizard process.
6. Select **Local printer attached to this computer**, then click **Next**.
7. Select **Use the following port:** then from the drop down menu, select USB port.
8. Click **Next** to proceed.
9. Click **Have Disk...** button to browse the location of unzipped driver file.
10. Select **MantraJet_1050.inf** then click **OK**.
11. Printer should be highlighted, click **Next** to proceed.
12. Enter Printer name or leave default name.
13. Select desired default printer option, then click **Next**.
14. Select, **Do not share this printer**, then click **Next**.
15. Select **No**, to print a test page option, then click **Next**.
16. Click **Finish** to complete the Add Printer Wizard.
17. Click the **Continue Anyway** button on the Windows compatibility window.
18. Wait till the **Copying Files...** progress window finish.
19. This completes the printer driver installation.

FAQ:

- 1. Can I use other software than included label editor?**
Yes, you can. As a matter of fact you can use any Windows application such as Adobe Photoshop, Corel Draw etc... All you need to know is where the printable circle is located.
- 2. Can I use SureThing artwork files created for Primera or Microbards printers?**
Yes, with the latest version you can use artwork created for other printers. All you have to do click on the layout type blue text above the design area and select the desired new type - for example "Yurex, Inc. full face".
- 3. What type of ink cartridges are supported?**
Use original HP 27, 28, 56, 57 cartridges. One can also use refilled cartridges but one has to do it at their own risk. Such cartridges might explode, spilling all over the inside of the printer. Our warranty is voided in case of such accident.
- 4. Can I print on 80mm or business card type of CD?**
No, You cannot. Our feeding mechanism supports only standard 120mm optical disc medium.
- 5. Will MantraJet printer work with Windows XP, Vista, or Windows 7?**
Yes, MantraJet driver versions 2.xx will work with Windows XP, Windows Vista, and Windows 7.
- 6. Will MantraJet printer work with Windows 7, 64-bit technology?**
Yes, we released a BETA 2.xx version of MantraJet driver for 64-bit Windows 7.
- 7. Will MantraJet printer work with Mac?**
No, MantraJet will not work on Mac.